

# 25906 - Traxer 5.6 Anthra/Anthra

# Hapro

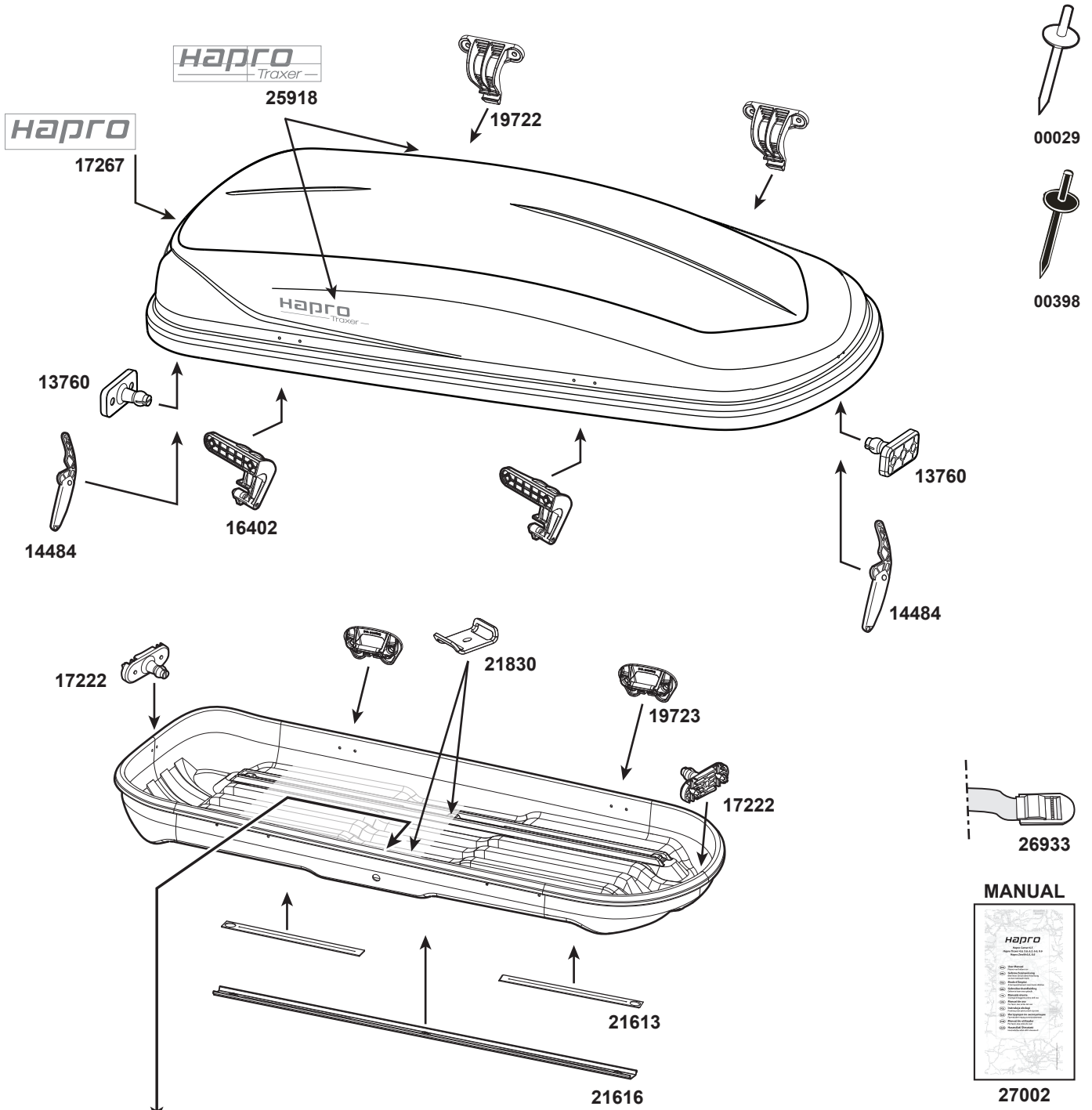

## SYSTEM A

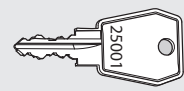
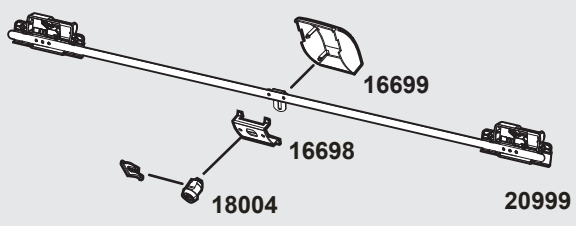

No.:

2	5		
---	---	--	--

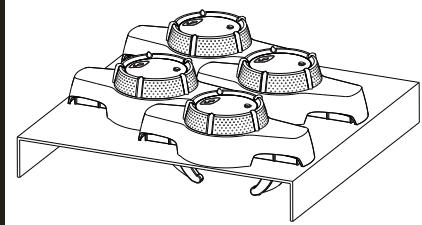

ART.NO: 27000

## SYSTEM B

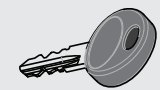
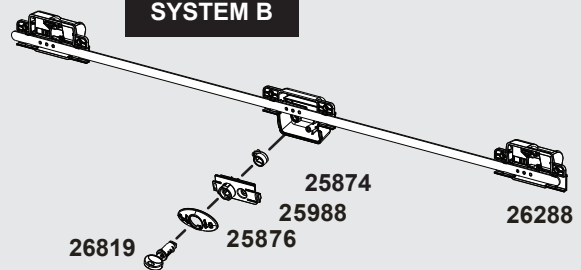

No.:

2			
---	--	--	--

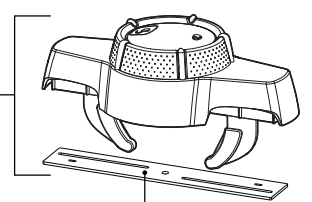

ART.NO: 21612

ART.NO: 27001